

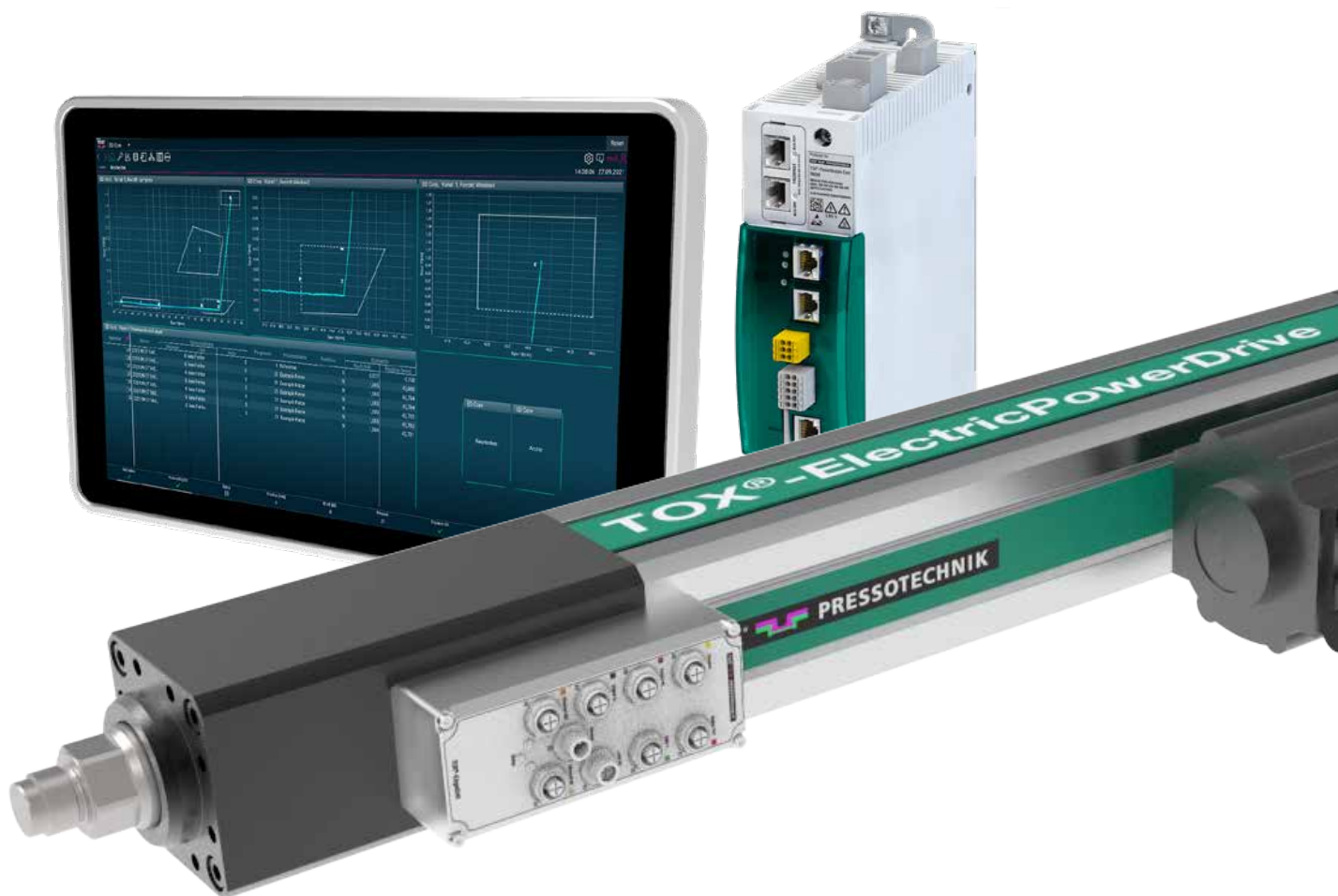

# TOX<sup>®</sup> ElectricDrive

Electrical drive technology – smart and intelligent



# The TOX® ElectricDrive Core System

The new TOX® ElectricDrive Core System with its electrical drives can be used in a wide range of applications. The highly flexible integration into existing control environments saves time and costs – drive control, process monitoring and quality assurance are combined in one system. The intuitive HMI meets all your requirements – you decide whether the TOX® Software is run on our HMI panel or on your PC on customer-side.

## TOX® ElectricPowerDrive

The powerful drives with forces from 0.02 - 1000 kN. Interfaces and sensorics offer highest flexibility.



## TOX® EdgeUnit

The decentralized intelligence for every drive

## TOX® PowerModule Core

- Servo inverter with application for force-travel control included
- Main interface and connection to the fieldbus system
- All functions of your application are pre-parameterized



## TOX® Software

- Visualization and HMI
- Storage of the quality data or forwarding to server
- Operating system independent (Windows/Linux)
- On customer PC / line PC or TOX® UDI Panel (available in 10", 13" and 21")

## System overview TOX® ElectricDrive Core

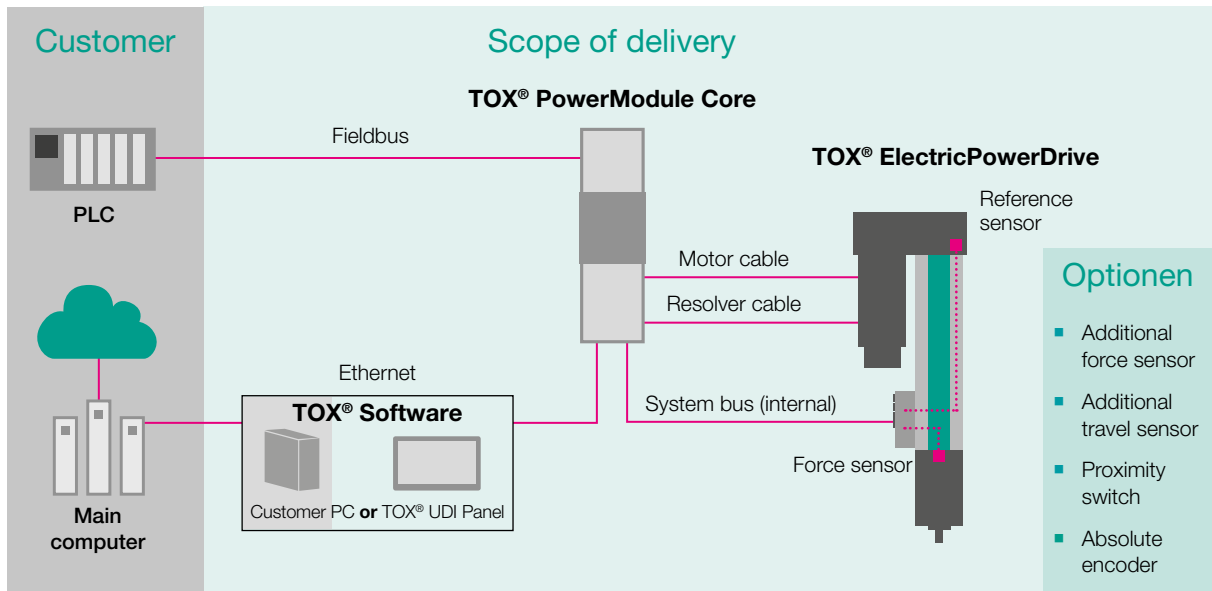

## Advantages

- Fast commissioning due to the intuitive operation of the software: Plug-and-Play
- Cost saving due to slim control architecture
- Seamless quality assurance
- Predictive maintenance ready
- Quality data and evaluation in one system

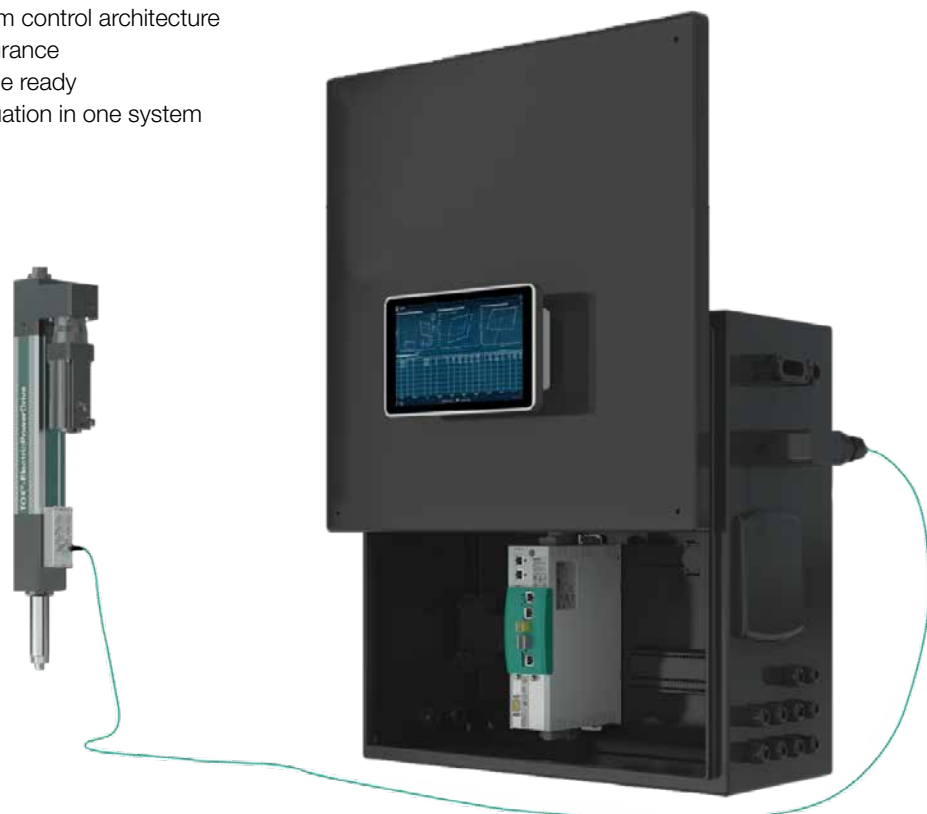

# Versatile applications

The TOX® ElectricDrive Core System is perfectly suited for precise and powerful use in joining machines, assembly machines, presses, robot tongs and special machines. The system ensures maximum productivity in a wide range of applications.

## Joining and Assembling



Clinching

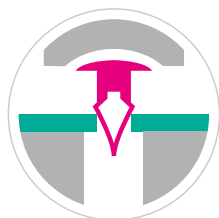

Clipping

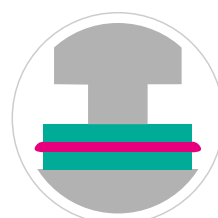

Pressing,  
Compressing



Crimping

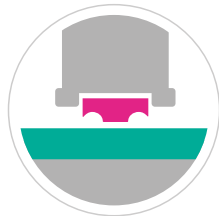

Insertion of  
functional elements



Punching,  
Piercing

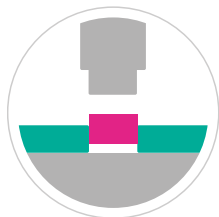

Press Fitting,  
Installing



Riveting

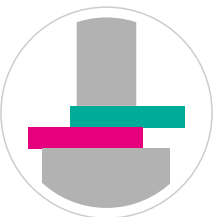

Tightening,  
Clamping

## Advantages of the drive system

- Common applications are pre-parameterized
- Easy adjustment of the process parameters
- Fast changing of applications
- All combined in one system



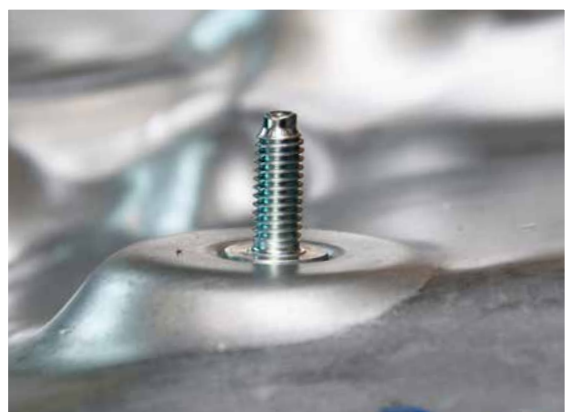

## Forming



Bending



Molding

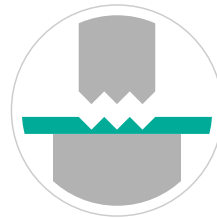

Stamping,  
Marking



Deep drawing

## Checking and Testing

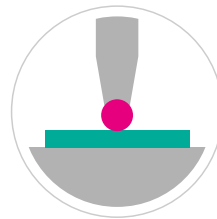

Checking,  
Measuring

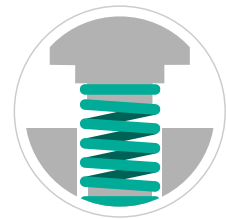

Testing

## TOX<sup>®</sup> Laboratory tests for you!

We test your application with your piecepart in our in-house test laboratory. Thus we guarantee an optimal combination of drive and application.

# The electromechanical servo drive

With the TOX® ElectricDrive you get an energy-efficient drive solution for various applications with a usable press force range up to 1000 kN. The drives are equipped with either ball screws or planetary roller screws.

## Low maintenance costs

The electromechanical servo drives TOX® ElectricPowerDrive are designed in such a way that minimal maintenance is required.

- Maintenance-free servo motors
- Maintenance-free belt drive
- Long lubrication intervals of the drives (automatic lubrication systems are available)

### Ball screw spindle



This screw assembly consists of a thread and a nut with recirculating balls in a closed system.

### Planetary roller screw spindle

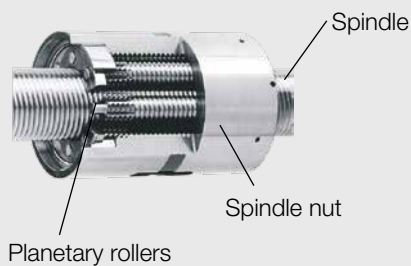

Here, planetary rollers installed in the spindle nut rotate around the spindle. The high number of force-transmitting contact surfaces can take high loads, with compact dimensions.

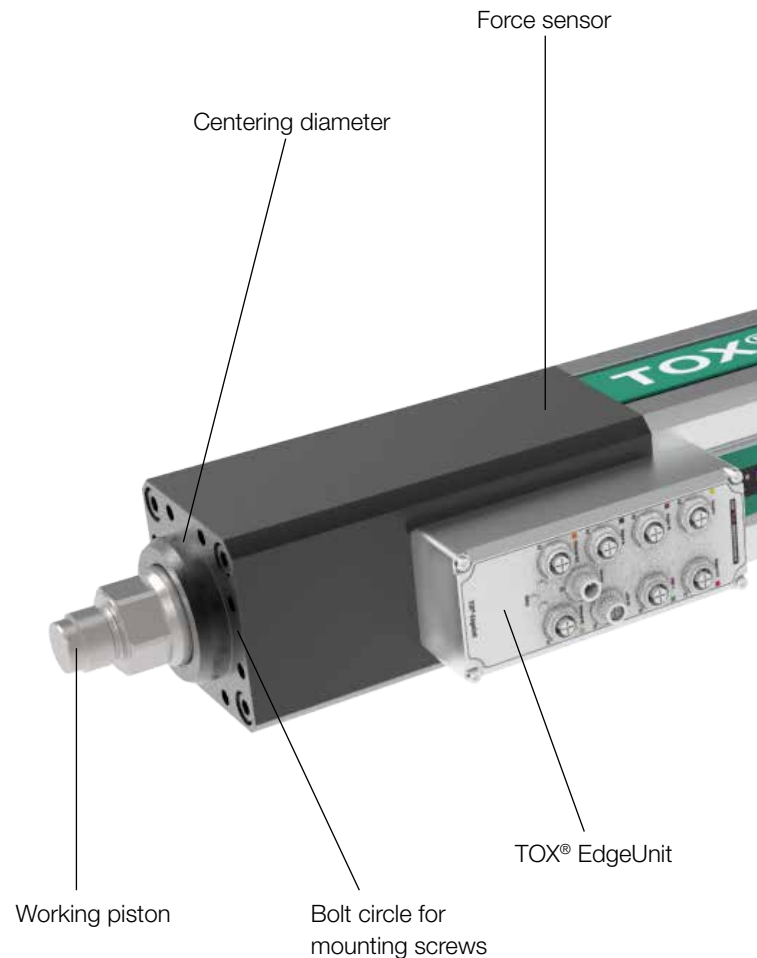

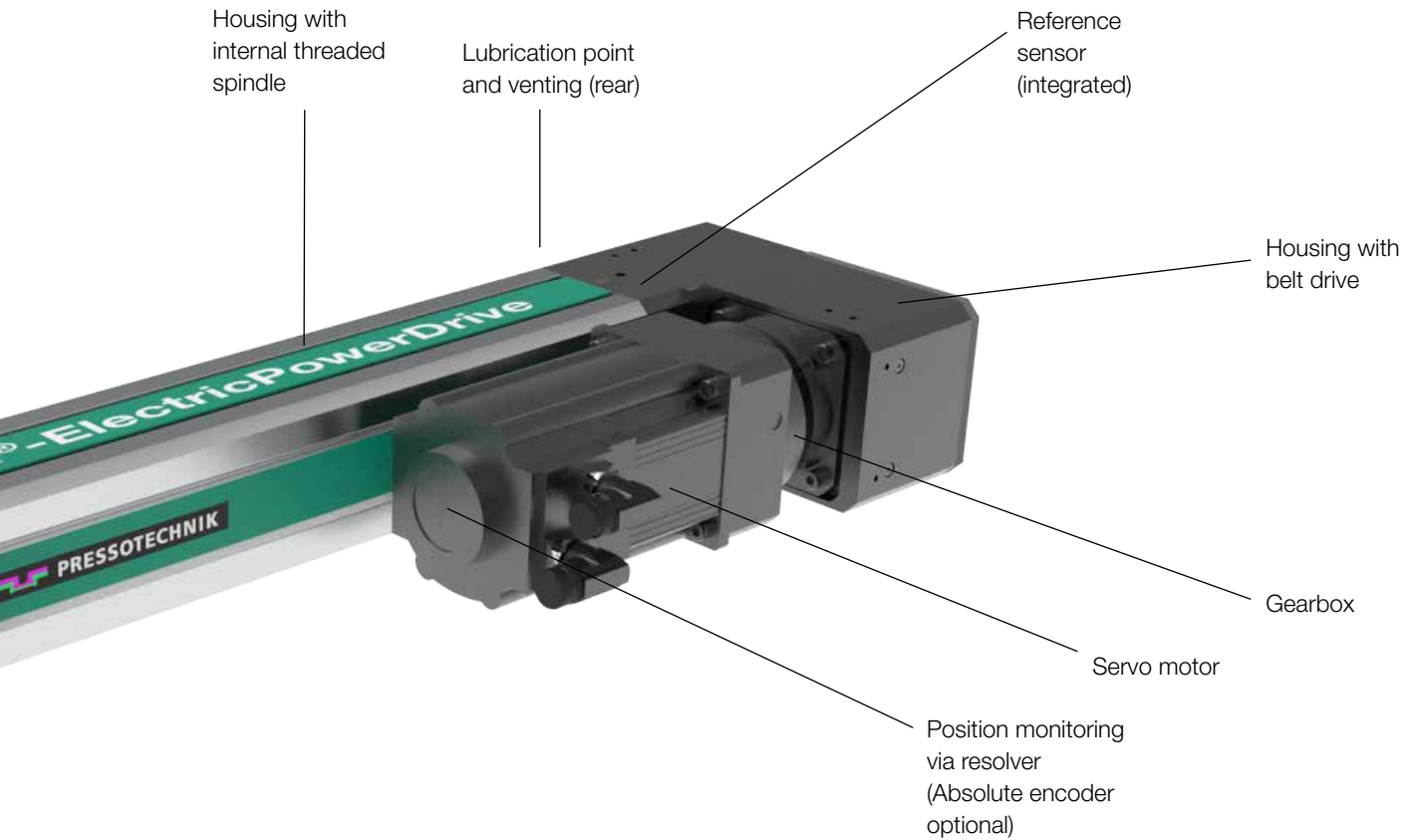

## Proven and Energy Efficient Drive Technology

- Robust and durable
- High energy efficiency
- Low operating costs
- High mechanical precision
- Precise repeatability
- Anti rotation feature

## Special versions

### Design:

- Variable mounting version
- Variable lubrication position
- Frontal mounting of tools
- Modified stroke length
- Narrow design

### Certifications:

- Protection type IP65
- Cleanroom air-cleanliness class 5 according to ISO 14644-1

### Cycle optimized:

- Long force holding time
- Reduced cooling time
- Force pulling or punching
- Increased speed



# The complete electromechanical drive family

---

## EQe

- Cost effective
- Ball screw spindle
- Polynom calibration
- 4-point force measurement

### TOX® ElectricPowerDrive EQe-K

- Press force range 0.02 kN – 100 kN
- Available in types  
2 kN / 5 kN / 10 kN / 30 kN / 60 kN / 100 kN
- Total stroke 150/300/450 mm
- Speed up to 300 mm/s



The cost efficient  
Drive System

#### Applications:

Pressing, joining, single drive with medium space requirement

## EXe

- Smaller space requirement
- High precision, 4-element force measurement
- High power density with low weight
- Special versions for individual customer needs (length, speed, protection class)
- Planetary roller screw spindle
- Polynom calibration

### TOX® ElectricPowerDrive EXe-K

- Press force range 0.1 – 200 kN
- Available in types  
10 kN / 30 kN / 60 kN / 100 kN / 200 kN
- Total stroke 150/300/450 mm
- Speed up to 300 mm/s



The high performance  
Drive System

#### Applications:

Insertion of functional elements, clinching, riveting, space limited pressing applications, punching



### TOX® ElectricPowerDrive EXe-F

- Press force range 0.05 – 100 kN
- Available in types  
5 kN / 10 kN / 30 kN / 60 kN / 100 kN
- Total stroke 150/300 mm
- Speed up to 800 mm/s
- Increased service life
- High acceleration

#### Applications:

Press applications  
requiring short cycle  
times

The extremely fast Drive  
System with up to  
800 mm/s



### TOX® ElectricPowerDrive EXe-L

- Press force range 3 kN – 1000 kN
- Available in types  
300 kN / 400 kN / 500 kN / 700 kN / 1000 kN
- Total stroke 300 mm
- Speed up to 90 mm/s

#### Applications:

Multi-point clinching and  
riveting, high force press  
applications

The powerful Drive System  
with up to 1000 kN

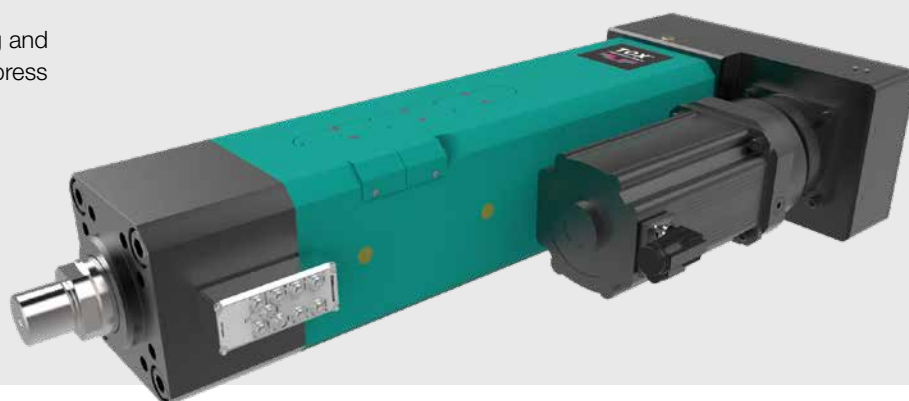

# Sensorics and Interfaces

The TOX® EdgeUnit is the decentralized intelligence of the TOX® ElectricPowerDrive. The integrated force sensor is directly located next to the measuring amplifier of the TOX® EdgeUnit. No complex cabling – no susceptibility to electromagnetic interference. In addition, a second DMS measuring amplifier is available for closed-loop monitoring – a full-featured second measuring channel.

## Integrated Force sensor



- 4 x DMS with < 0,5% measurement accuracy
- Spatial position independent itself compensating
- Internal connection with the TOX®-EdgeUnit
- Measurement amplifier and 16 Bit ADC

## Intelligent TOX® EdgeUnit

- Onboard memory for:
  - electronic type plate
  - service and stroke counter
  - drive data and calibration factor
- 2 digital inputs and outputs
- Encoder input (TTL)
- 2 analog inputs
- Additional measuring amplifier (16-Bit)

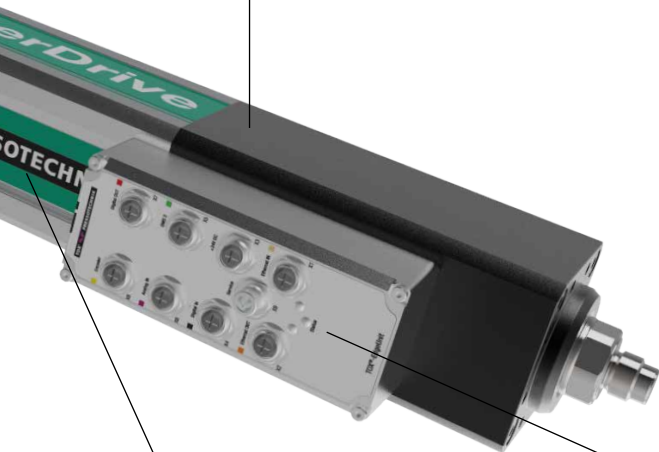

## Integrated Reference sensor



- Internal connection with the TOX® EdgeUnit
- Redundance for the reference (additional to currency increase or fixed stop)



# TOX® PowerModule Core

The TOX® PowerModule Core serves as servo inverter for power provision in the system as well as central intelligence of the drive control. Furthermore, the fieldbus interface to the higher PLC/ to the higher robot is integrated.

The TOX® PowerModule Core is parameterized with the TOX® Software. The connection of the TOX® UDI Panel or customer PC takes place via Ethernet (TCP/IP).

## Powerful Controller

- Force or function control
- Individual acceleration and deceleration
- Pressing in on PLC preset values
- Driving on position or on force or both combined
- Multiple operation (access to a process and task at once)
- Taring the force sensor

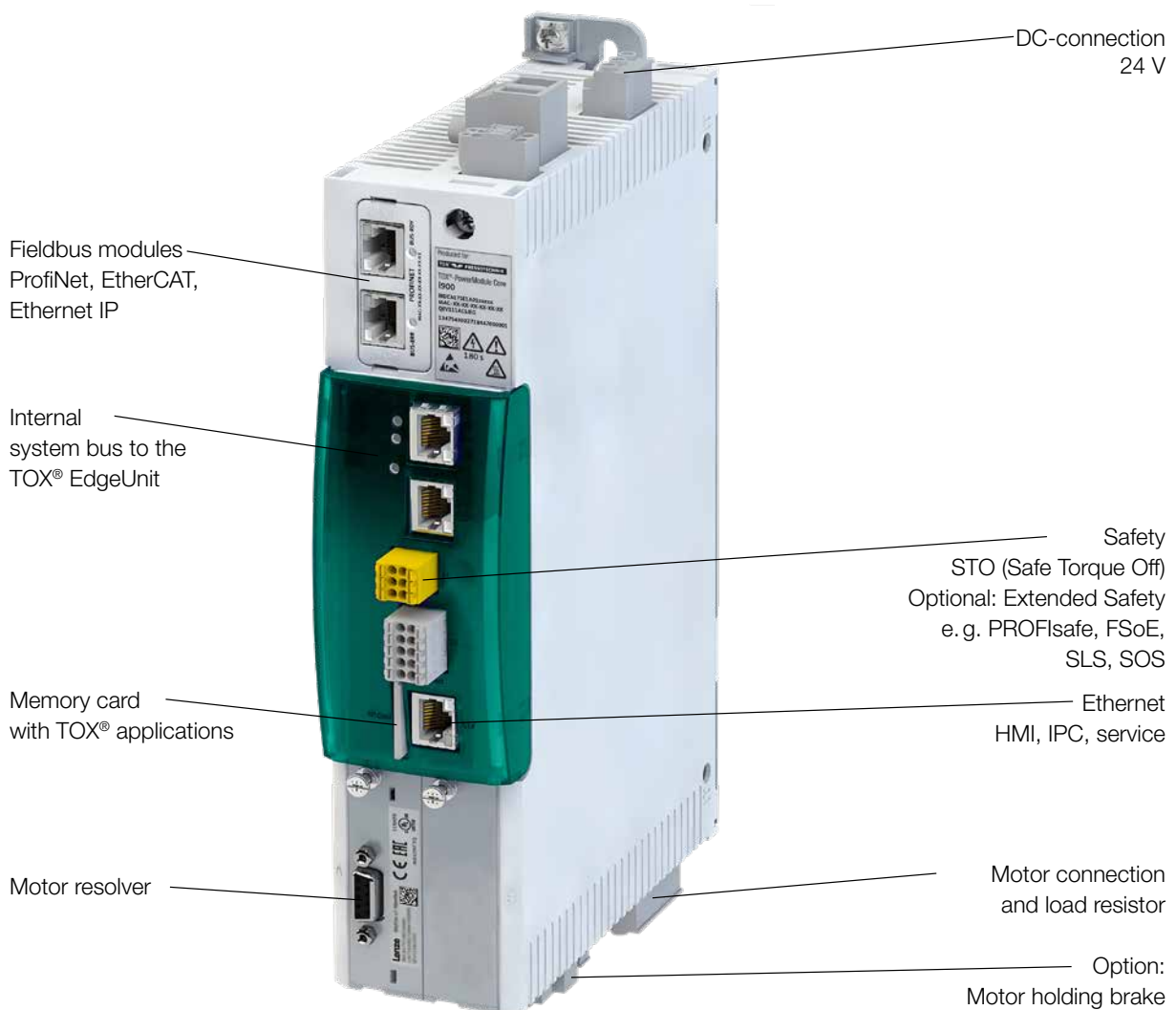

# TOX® Software

Whether you are working with the new TOX® Software as operator, repairer, process engineer, commissioning engineer or quality manager, the HMI impresses with a customizable user interface as well as clear, freely definable dashboards. Parameterization, operation, process monitoring, diagnosis and evaluation as well as quality data management are all combined in the TOX® Software.

The TOX® Software takes over the control of the TOX® PowerModule Core, which controls the TOX® Electric-PowerDrive. The communication takes place in real time and guarantees high repeatability and highest performance of the process control.

## Technical Data

- 5 windows per process freely definable
- 500 software programs
- 2 channels e.g. force 1 / force 2 on position
- Flexible fieldbus with 32 words
- 10 tracks in one diagram
- 5000 diagram points per track

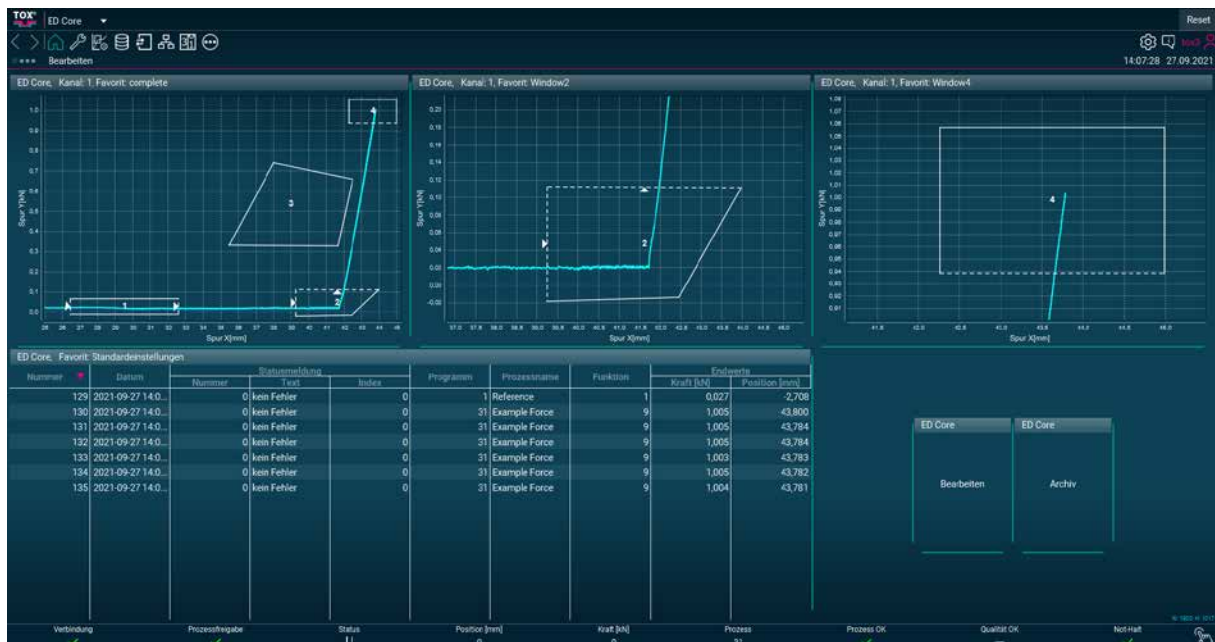



## Userfriendly Software

- Modern user interface „look and feel“
- Widget based for customizable dashboards
- Intuitive handling
- Easy installation and parametrization
- Integrated window technique for many applications

## TOX® UDI Panels

The TOX® Software can be installed either on a customer's PC or on a TOX® UDI Panel. This is available in 3 different versions:

10"



Hand panel: upright or horizontal operation.

13"



For built in or mounting on a support arm, upright or horizontal.

21"



## Technical Data

- Integrated PC
- IP 65 protection type
- No UPS battery necessary
- 250 GB SSD hard disk
- Resolution max. Full HD 1920 x 1090 Pixel

# Process monitoring with Window Technique

During operation, the system continuously supplies force-displacement curves, which are used for monitoring application processes. The TOX® Software takes over the evaluation of the curves and their documentation. On the basis of these measurement curves, the quality of an individual production step, an assembly or the entire product can be monitored and controlled in real time.

With the help of various windows, even complex XY curves can be monitored and controlled in detail according to requirements.

## Must cross

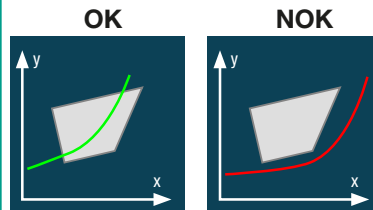

The curve must cross the defined window.

Application: Monitoring of the force-travel progress during pressing in of elements

## Enter and Exit

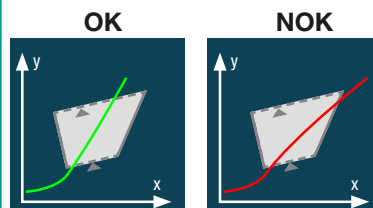

The entry and exit sides can be freely defined and will be monitored.

Application: Monitoring of the force-travel progress during pressing in of elements

## Innovative Window Technique

- Complete process monitoring integrated (e.g. enter and exit points, touch and crosspoints)
- Window and Envelope Technique
- Calculation functions

### Extended Lines

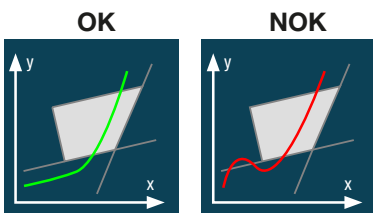

The extended lines define a region. The force-travel-curve must enter the window without touching and crossing these lines.

Application: Monitoring of the force-travel progress during pressing in of elements

### Average

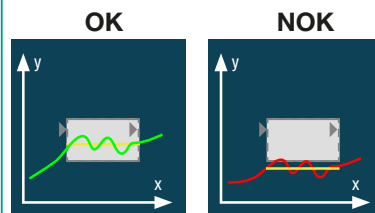

An average value is calculated and monitored within the window.

Application: Control of the average force applied to a piece part when clamping, forming or molding.

### Time Monitoring

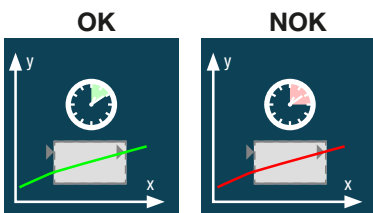

Detection of the time between entry and exit.

Application: Monitoring of time functions e.g. flowrate of material during deformation

### Slope detection

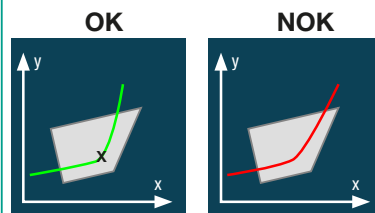

The slope has to reach a defined value. This value will be recorded and is relevant for other actions.

Application: Part recognition during press-fitting and compensation of tolerance variations

### Slope detection

Digital Input

Integral

Differential Average

Differential Actual Values

The actual gradient is recorded and evaluated (derivation).

Application: Evaluation of the fit tolerance of a piece part

### Hysteresis

Intersection within the window

Load Drop

Forecasting

Two values are recorded and a calculation is performed which results in a new target window.

Application: Measuring of piece parts during pressing operations

# Networked Production and Quality data

Digitization is making its way into industrial production. Modern information and communication technology enables self-organized production, so that people, machines, plants, logistics and products communicate and cooperate directly with each other. Intelligent and digitally networked systems are necessary for this.

## Data Connection and Network

Thanks to numerous interfaces, the TOX® ElectricDrive Core System can be excellently integrated into a network - be it a machine, a production line or an entire company network. The system components communicate with each other via fieldbus.

## Quality data for further processing

The data generated in the network makes it possible to monitor and improve the processes on an ongoing basis. Feedback from the production process can be used to optimize technology parameters. Links of component serial numbers to the respective process quality data are possible and can be stored permanently. Unnecessary maintenance work and downtimes can be avoided thanks to predictive maintenance.

## Future-oriented Features

- Interfaces for connecting peripheral devices via Industrial Ethernet
- Plug & Play installation
- Fast application changeover
- Modular design
- Import of process parameters from the production network
- Dynamic adaptation of process settings
- Data exchange via communication protocols such as OPC UA and MQTT

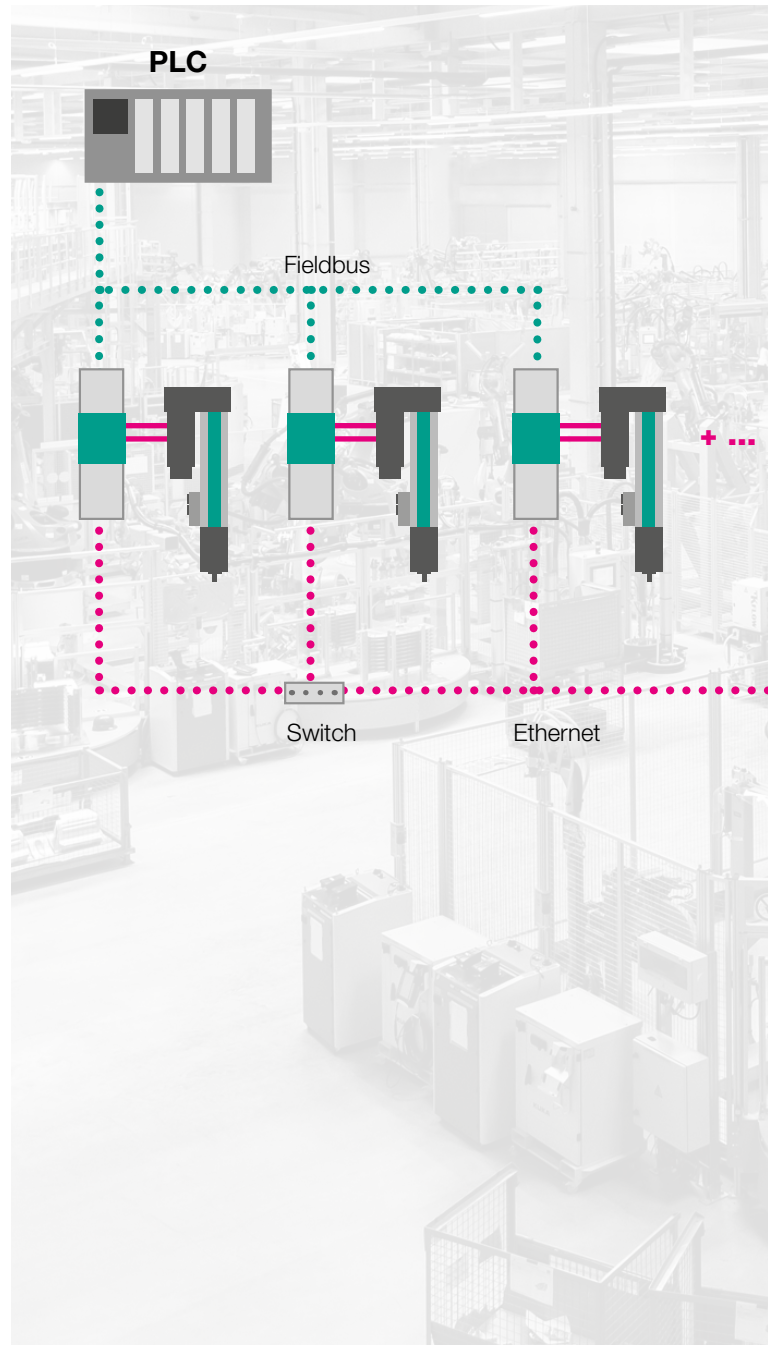



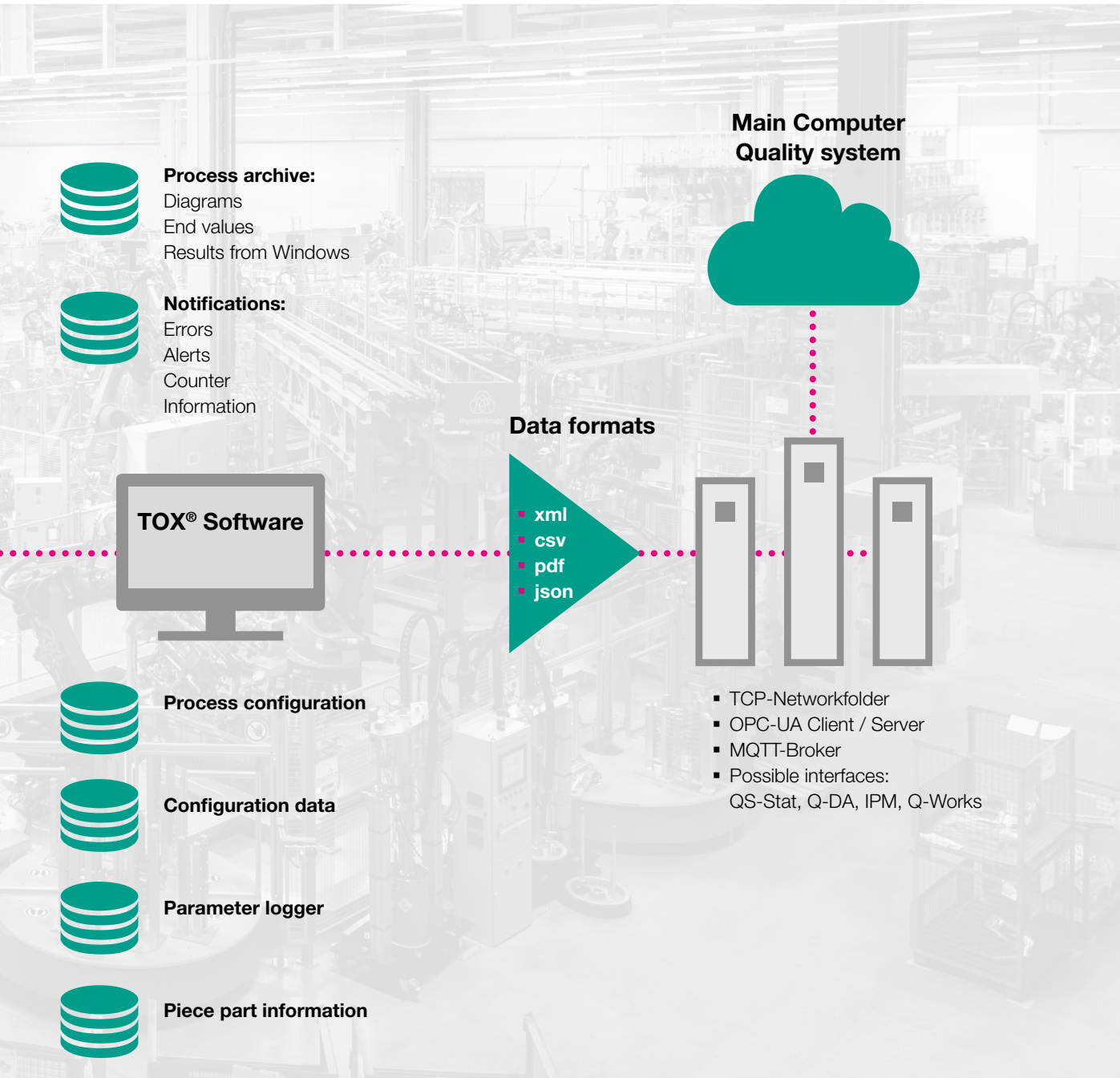

# Accessoires and Options

---

With various accessories and expansion options, the system can be adapted and equipped to meet the individual requirements of the application.

## Automatic lubrication device

All drives can be equipped with an automatic lubrication device. This ensures optimum, minimal lubrication of the drive.



## Fan

The drives can be equipped with a fan. This cools down the motor and enables higher power density and thus higher cycle rates. It also enables sustained high press-in forces.

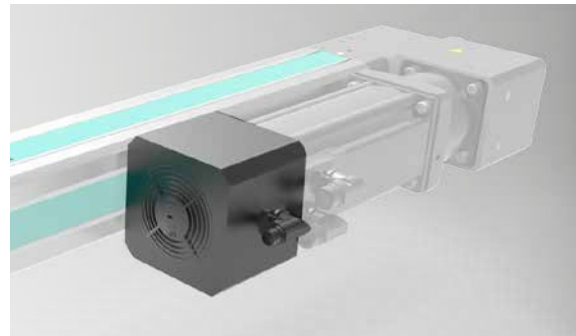

## Force sensor

Additional force sensors at important positions measure the relevant forces.



## Piezo-electric sensors

Upon request, a piezo sensor can be integrated.

## Proximity switch

For detecting positions of workpieces and tools.



## Travel sensor

The drive system can be equipped with sensors for precise deflection-independent measurement of travel, distance and position.



## External linear position sensor

To measure distances between objects and a reference point or changes in length independent of deflection, external travel measuring systems (glass scales) are used.



# Safety Equipment

---

## Motor holding brake (intern)

The motor holding brake prevents the weight-loaded working piston from dropping when the system is de-energized. The motor holding brake is connected via the motor cable included in the cable set.

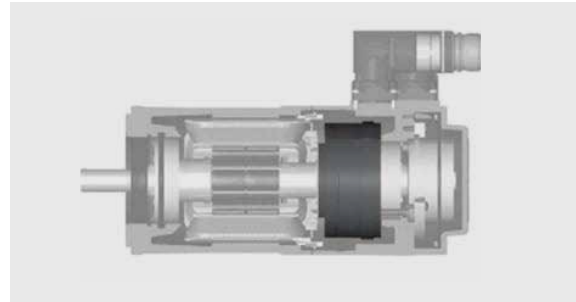

## Safety brake (mounted on the drive)

The safety brake for the drives EQe-K, EXe-K and EXe-L is designed as a spring-applied brake. This means that when a power loss occurs, the brake closes and stops the drive and the dynamically loaded working piston.

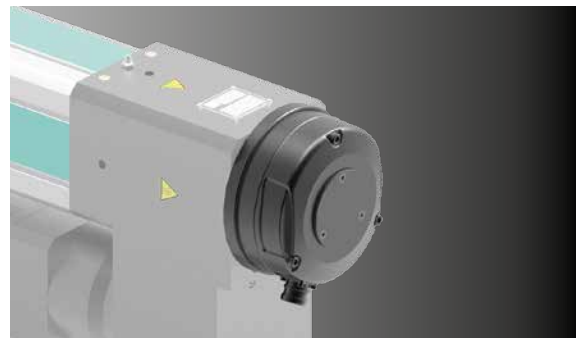

## TOX PowerModule Core with Extended Safety

Using the Extended Safety-Controller all safety options can be applied:

PROFIsafe, FSoE:

- SOS (Safe Operating Stop)
- SLS (Safely Limited Speed)
- more on request

For operator safety an external encoder can be mounted on the safety brake.



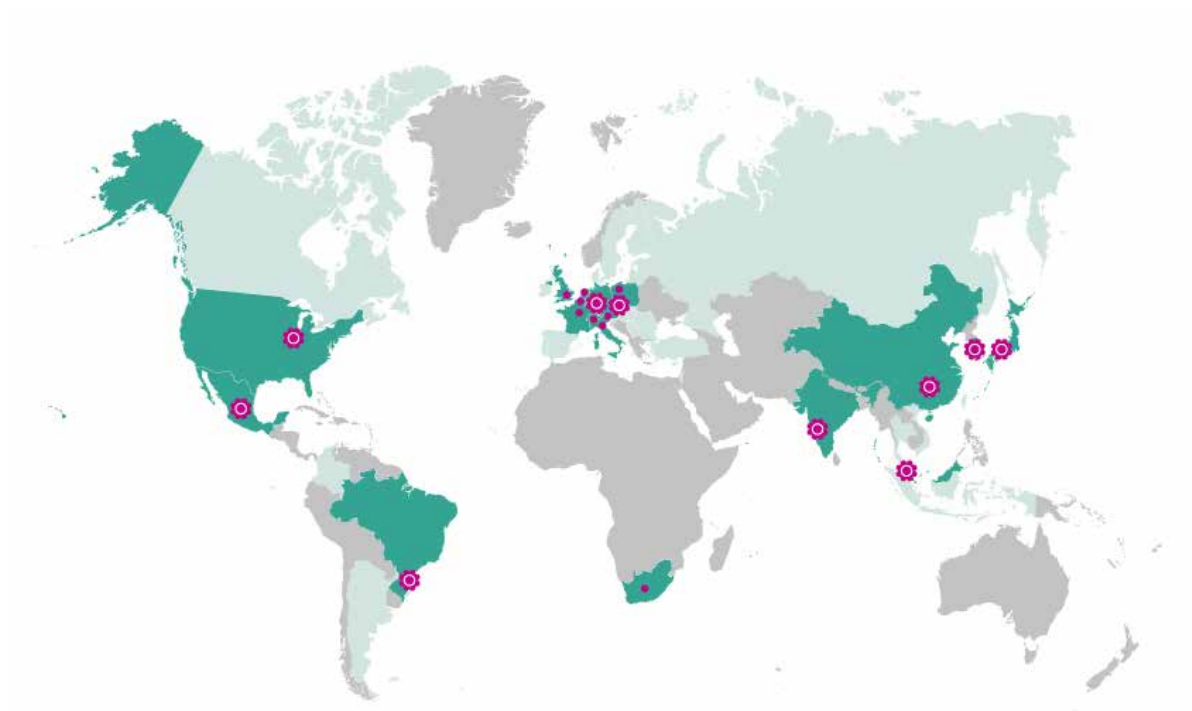

TOX® PRESSOTECHNIK GmbH & Co. KG  
Riedstrasse 4  
88250 Weingarten / Germany

Find your local contact at:  
[www.tox.com](http://www.tox.com)